

RELS30-110B12 DC/DC Converter

Input 40V ~ 160V Output 12V/2.5A 1in.×2in. Industry Standard Size

Contents

- Outline Diagram.....1
- Features.....1
- Specifications.....1
- Characteristic Curves.....3
- Design Considerations.....5
 - Basic Connection.....5
 - Recommended Layout.....5
 - External Capacitance.....5
 - Remote Control.....5
 - Output Voltage Adjust.....6
 - EMC Solution.....7
 - Safety Consideration.....7
 - Thermal Consideration.....7
 - Series and Parallel Operation.....7
 - ESD Control.....8
 - Cleaning Notice.....8
- Delivery Package Information.....8
- Quality Statement.....8
- Contact Information.....8



Features

- 1in.×2in.Industry Standard Size (50.8mm×25.4mm×12.7mm)
- Wide Input Voltage (40V~160V)
- Positive Logic Control(3.5V to 15V turn on)
- Output Voltage Adjust Rang:±10% of the rated output voltage
- Output short-circuit protection, hiccup, auto-recovery
- High efficiency, 87% typ.(Input 110V, I_{nom})
- 1500Vac Isolation Voltage
- Operating Ambient Temperature:-40 to 85
- Meets Requirements of Standard EN50155
- Application: Rail transit

Outline Diagram

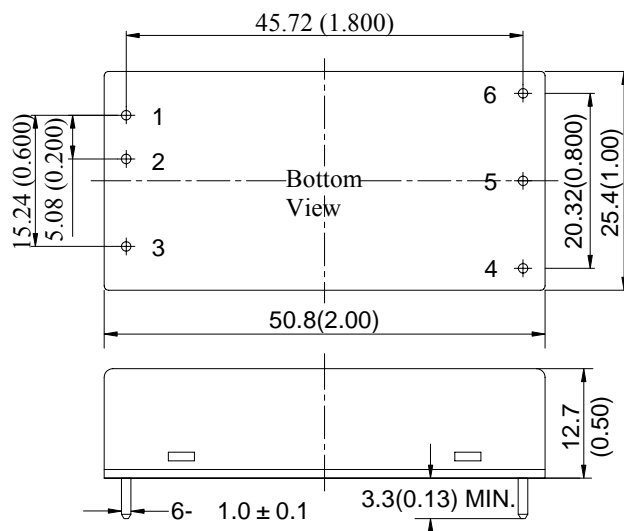

Pin	Symbol	Function
1	+Vin	Positive Input
2	-Vin	Negative Input
3	CNT	Remote Control Pin
4	TRIM	Output Voltage Adjust
5	-Vo	Negative Output
6	+Vo	12V Positive Output

Case material:Aluminum shell plastic cover, black
 Pins material: Copper with gold plating
 Notes: all dimensions in mm(inches)
 X.X±0.5 (X.XX±0.02)
 X.XX±0.25 (X.XXX±0.010)

Specifications

Unless otherwise specified, all tests are at room temperature and standard atmosphere, pure resistive load.

Input	Symbol	Min	Typ	Max	Unit	Conditions
Input Voltage	V _{in}	40	110	160	V	—
Input Current	I _{in}	—	—	0.9	A	V _{in} =40V, I _o =2.5A
Start-up Delay Time	T _{delay}	—	8	—	ms	—
Input Idling Current	I _{in,nl}	—	—	35	mA	V _{in} =110V , I _o =0A

RELS30-110B12 DC/DC Converter

Input 40V ~ 160V Output 12V/2.5A 1in.×2in. Industry Standard Size

Continue

Input		Symbol	Min	Typ	Max	Unit	Conditions
Positive Logic Remote Control	ON	-	3.5	-	15.0	V	Refer to $-V_{in}$; Also turn on when CNT floating
	OFF	-	0	-	1.5	V	Refer to $-V_{in}$
	Current	-	-	-	5.0	mA	CNT source current when turn off
Under Voltage Threshold		V_{UVLO}	34	-	38	V	—
Under Voltage Protection Hysteresis		V_{UVLO}	1	-	2.5	V	—

Output		Symbol	Min	Typ	Max	Unit	Conditions
Output Voltage		V_o	11.88	12.00	12.12	V	—
Output Current		I_o	0	-	2.5	A	—
Output Voltage Adjust Range		V_{trim}	10.8	-	13.2	V	$I_o \leq 2.5A, P_o \leq 30W$
Line Regulation		S_V	-	-	± 0.2	%Vo	$V_{in}: 40V \sim 160V, I_o = 2.5A$
Load Regulation		S_I	-	-	± 0.5	%Vo	$V_{in} = 110V, I_o: 0A \sim 2.5A$
Over Current Protection Level		$I_{o,lim}$	2.75	-	5	A	—
Output Over-shoot		V_{TO}	0	-	1.2	V	$V_{in} = 110V, I_{o,max}$
Output Short-circuit Protection		Hiccup mode, auto-recovery					
Peak to Peak Ripple and Noise		V_{pp}	-	-	120	mV	20MHz bandwidth
Rise Time		T_{rise}	-	5	-	ms	$I_{o,max}$ pure resistive load
Capacitive Load Range		C_o	100	-	1000	μF	—
Load Transient	Recovery Time	t_{tr}	-	-	400	μs	25%~50%~25% $I_{o,max}$ or 50%~75%~50% $I_{o,max}$; 0.1A/ μs
	Voltage Deviation	V_{tr}	-	-	± 600	mV	

General		Symbol	Min	Typ	Max	Unit	Conditions
Efficiency		η	-	87	-	%	$V_{in} = 110V, I_o = I_{o,max}$
Switching frequency		f_s	-	300	-	kHz	—
Isolation Resistance		R_{iso}	50	-	-	M Ω	—
Isolation Voltage		V_{iso}	1500	-	-	V_{ac}	Input to Output Input to Case Output to Case Leakag Current t 5mA
Shock And Vibration		Meets EN50155					
MTBF		-	-	2×10^6	-	h	BELLCORE TR-332
Operating Case Temperature		-	-40	-	+105		See the Natrual Cooling Derating

RELS30-110B12 DC/DC Converter

Input 40V ~ 160V Output 12V/2.5A 1in.×2in. Industry Standard Size

Continue

General	Symbol	Min	Typ	Max	Unit	Conditions
Operating Ambient Temperature	-	-40	-	+85		See the Natrual Cooling Derating
Storage Temperature	-	-55	-	+125		—
Temperature Coefficient	S _T	-	-	±0.02	%/	—
Thermal resistance	R _{θCA}	-	16.29	-	/W	Natural convection without heatsink
	R _{θCA}	-	13.66	-	/W	100LFM convection without heatsink
	R _{θCA}	-	10.93	-	/W	200LFM convection without heatsink
Hand Soldering	Maximum soldering Temperature < 425 , and duration < 5s					
Wave Soldering	Maximum soldering Temperature < 255 , and duration < 10s					
Weight	-	-	30	-	g	—

EMC Specifications	Standards & Conditions		Level
EMI Conducted Emission	EN55032	(See Page 7)	Class A
Surge Immunity	IEC/EN61000-4-5 GB/T 17626.5	line to line(±1kV/2Ω) ; line to ground(±2kV/12Ω) (See Page 7)	B
Fast Transient	IEC/EN61000-4-4 GB/T 17626.4	±2kV(5/50ns, 5kHz) (See Page 7)	A

Characteristic Curves

Load Transient Response

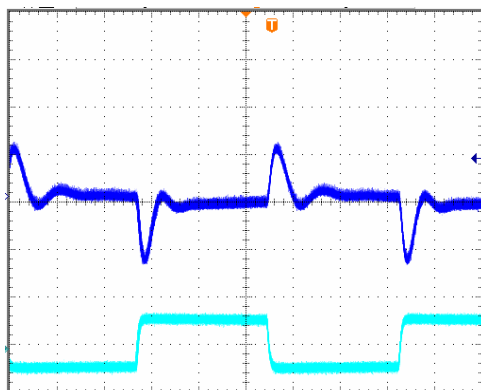

Load change: 25%~50%~25%I_{o,max.},
0.1A/µs , Vin=110V
Trace1: 100mV/div
Trace2: 0.6A/div
Timescale:400µs /div

Load Transient Response

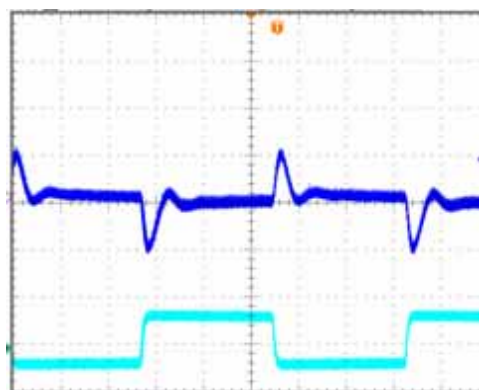

Load change: 50%~75%~25% I_{o,max.},
0.1A/µs , Vin=110V
Trace1: 100m V/div
Trace2:0.6A/div
Timescale: 400µs /div

Output Ripple

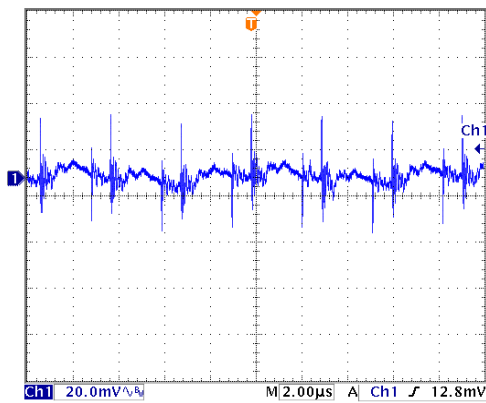

$V_{in}=110V, I_o=2.5A$

Rise time

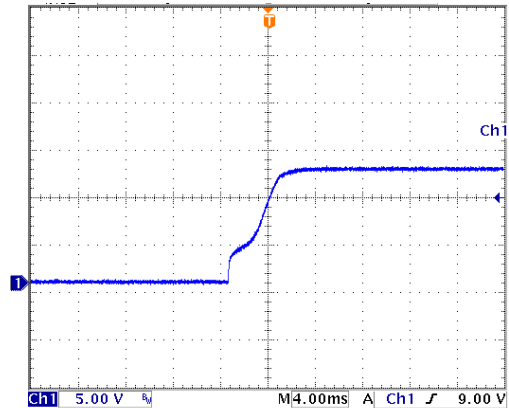

$V_{in}=110V, I_o=2.5A$

Turn-off

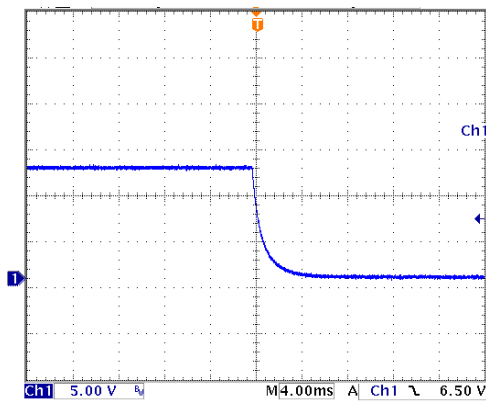

$V_{in}=110V, I_o=2.5A$

Start-up Delay Time

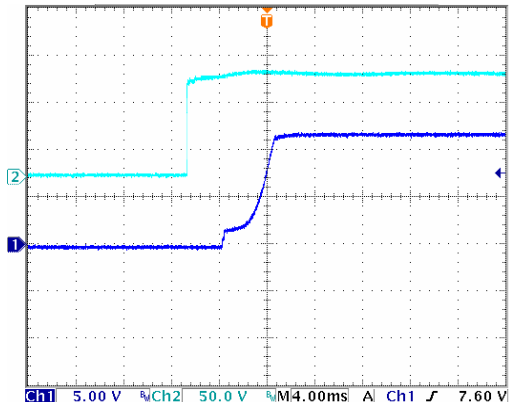

$V_{in}=110V, I_o=2.5A$

Efficiency vs. I_o & V_{in}

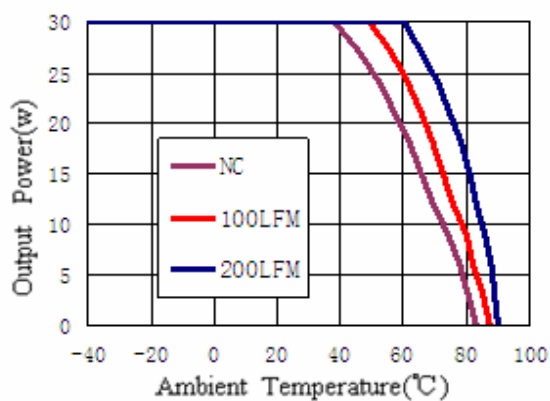

Derating Curves

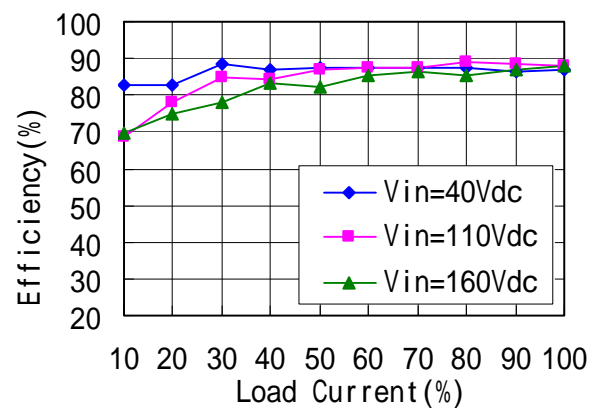

Design Considerations

Basic Connection

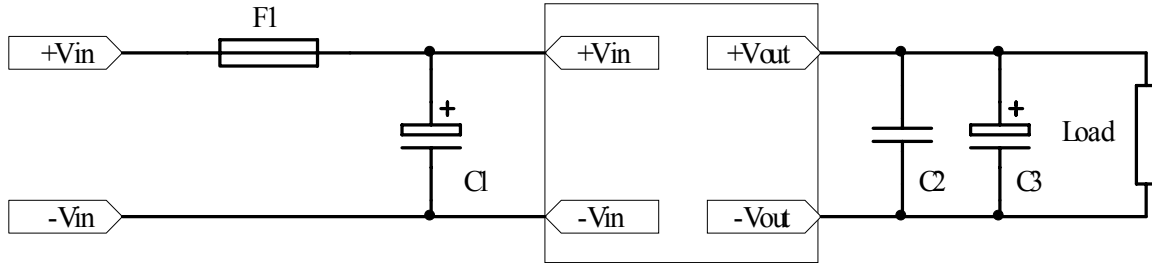

Notes: Please see the application information followed for the further information.

Parameter declaration:

Part No.	Model	Part No.	Model
F1	3A	C2	1μF
C1	47μF	C3	100μF

Recommended Layout

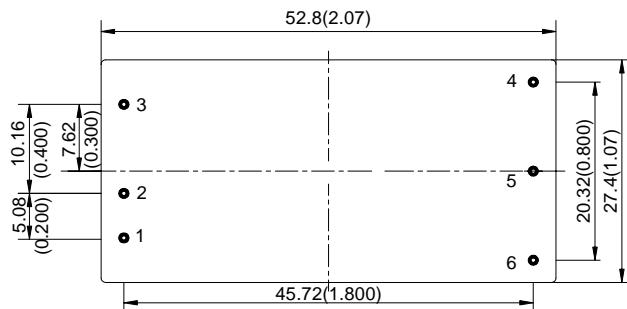

NO.	Recommendation & Notes
Pad Design	Pad holes 1.2mm, pad diameter including hole:2.5mm
Mounting Direction	Heatsink face up, for natural convection
Safety	Isolated Converters, care to the spacing between input and output
Electrical	The Vin(-) and Vo(-) planes should be placed under of the converter separately. Avoid routing sensitive signal or high disturbance AC signal under the converter

External Capacitance

Unless special purpose (i.e. prolonging hold-up time, input impedance matching), the recommended input filter's capacitance ranges 47μF to 220μF, which not only offers a stable system, and reduces the cost, but also lessens the inrush current when the power supplies.

When larger capacitance is required, a circuit of suppressing the inrush current is recommended when the regulator start-up and a discharge circuit is recommended when the output dropped, ensuring the reliability and safety of other equipments in the system.

Remote Control

Remote control can be offered by setting right control voltage level (refer to -Vin pin) to CNT pin. Positive Logic Control: When the level is higher than 3.5V or be left floating, the converter will be on. When the level is lower than 1.5V, the converter will be off.

RELS30-110B12 is provided with positive logic remote. The

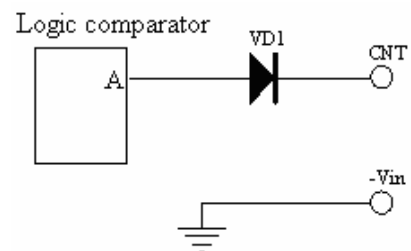

Internal circuit diagram for positive logic control

RELS30-110B12 DC/DC Converter

Input 40V ~ 160V Output 12V/2.5A 1in.×2in. Industry Standard Size

circuit diagram is shown as “Internal circuit diagram for positive logic control”. When low level applied, the CNT source current is less than 1mA, due to VD1 is signal diode, and the logic comparator is semiconductor integrated chip with low resistance to surge. Care should be taken to prevent CNT from surge, A TVS should be used in some cases.

In some applications, extra controls will be designed for the converter in user’s PCB, such as output short circuit protection, over voltage protection, under voltage protection, and so on, remote control will give you help. The controls can be achieved by external circuit applied to the CNT pin.

In some applications it is necessary to have a precise turn on and turn off level, or the level which can be received has a very narrow range, (such as turn-on between 5.0V-5.5V), the aux. circuit will be required. Please contact us for more information.

Output Voltage Adjust

The converters have an Output Voltage adjust pin (Trim). This pin can be used to adjust the output voltage above or below Output voltage initial setting. When increasing the output voltage, the voltage at the output pins (including any remote sense offset) must be kept below the maximum output adjust range, or the characteristics will not be assured in compliant with the specification, even the over voltage protection may be triggered. Also note that at increased output voltages the maximum power rating of the converter 30W remains the same, and the output current capability will decrease correspondingly, at decrease output voltages the maximum current should not exceed 2.5A. When the trim pin is not used, it should be floated.

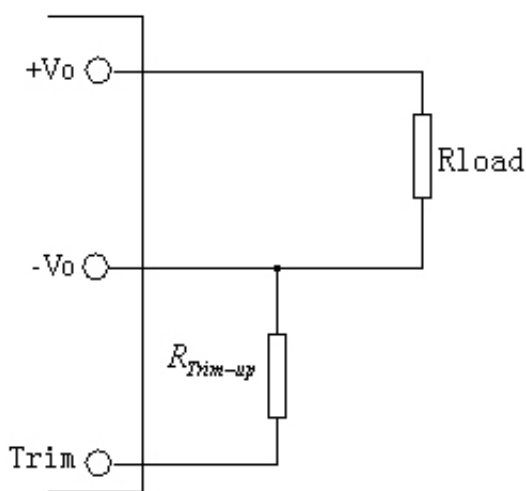
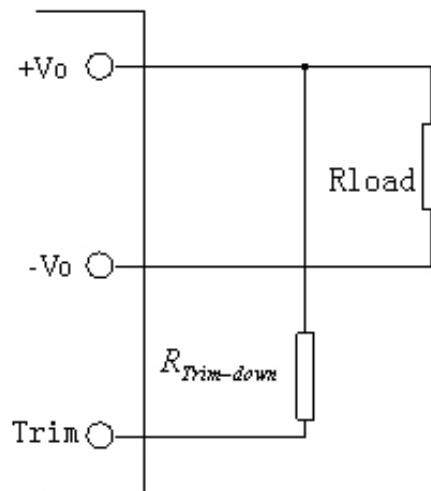
**Connection Of Trimming Up****Connection Of Trimming Down**

External circuit is connected as the figure shown, the resistance is calculated as the formula below, please note that the formula will be invalid when $R_{Trim-up}/R_{Trim-down}$ are used simultaneously, users adjust the value based on the resistance applied.

RELS30-110B12 DC/DC Converter

Input 40V ~ 160V Output 12V/2.5A 1in.×2in. Industry Standard Size

Resistance for trimming up: $R_{Trim-up} = \left(\frac{23.53}{\Delta V} - 15\right)(k\Omega)$

Resistance for trimming down: $R_{Trim-down} = \left(\frac{90.5}{\Delta V} - 24.41\right)(k\Omega)$

Vo: rated output voltage V: The output voltage change, Units: V;

$R_{Trim-up} / R_{Trim-down}$: Resistance for trimming up or down, Units: kΩ.

EMC Solution

Recommendation circuit for EMI Conducted emission、Fast transient/burst immunity、Surge immunity.

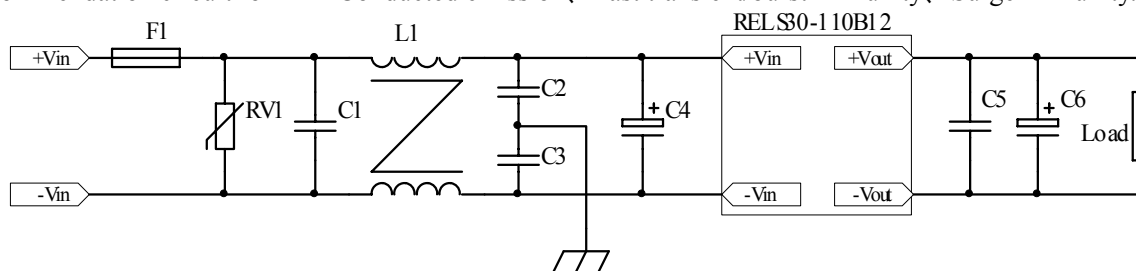

Parameter declaration:

Part No.	Components	Part No.	Components
F1	3A	C2/C3	1nF/250VAC
L1	2.5mH	C4	220 μ F
RV1	221KD14	C5	1 μ F
C1	0.33 μ F/275VAC	C6	100 μ F

Safety Consideration

To avoiding fire and be protected when short circuit occurred, it is recommended that a fast blow fuse with rating 2.5 to 4 times of converter’s continuous input peak current is used in series at the input terminal. (Inrush current suppression circuit is required for greater filter capacitance at input terminal, or it will result in the misoperation of the fuse).

Thermal Consideration

The converters operate in a variety of thermal environments, however, sufficient cooling should be provided to ensure reliable operation of the unit. Heat is removed by conduction, convection and radiation to the surrounding environment.

When case temperature is higher than the permitted operating, the derating curves should be referred or external heat dissipation measures. Forced air cooling or heatsink, should be used. The air tunnel should be considered for forced air cooling, to avoid heated air be hindered or forming swirl; when heatsink used, it should be attached the converter closely, through double-side thermal conductivity insulation adhesive or thermal conductivity silicone for heat exchange.

Series and Parallel Operation

The converters should not be paralleled directly to increase power, but they can be paralleled each other

RELS30-110B12 DC/DC Converter**Input 40V ~ 160V Output 12V/2.5A 1in.×2in. Industry Standard Size**

through o-ring switches or diodes. Make sure that every converter's maximum load current should not exceed the rated current at anytime if they are paralleled without using external current sharing circuits. The converters can operate in series. To prevent against start-up failure due to start up time difference, SBD with low voltage difference can be paralleled at the output pins (SBD negative terminal connect to the positive pin of the output) for each converter.

ESD Control

The converters are processed and manufactured in an ESD controlled environment and supplied in conductive packaging to prevent ESD damage from occurring before or during shipping. It is essential that they are unpacked and handled using an ESD control procedures. Failure to do so affects the lifetime of the converter.

Cleaning Notice

The converter case is not a hermetically-sealed construction, a sufficient drying process is required after the converter cleaning, make sure the liquid congregated is removed, or it will damage the converter or degradation of performance.

After surface treatment, the appearance of the converter may be affected by the organic solvent, protection measures should be taken before cleaning when appearance is concerned.

Delivery Package Information

Package material is multiple wall corrugated with more than $10^{12} \Omega$ surface resistance; Internal material is anti-static foam with more than $10^{12} \Omega$ surface resistance.. Tray capacity: $2 \times 16 = 32$ PCS/box, Tray weight: 1.03kg; Carton capacity: $8 \times 32 = 256$ PCS, Carton weight: 9kg.

Quality Statement

The converters are manufactured in accordance with ISO9001 system requirements, and are monitored 100% by auto-testing system, 100% burn in.

The warranty for the converters is 5-year.

Contact Information

Anhui Hesion Trading Co.,Ltd.

Beijing Yihongtai Technology Dev.Co.,Ltd

TEL: +86-551-65369069,65369067

FAX:+86-551-65369070

Email: alecz@ahhesion.com

Backup:alecz@126.com